

NAPPY BIN WP2505



298 x 780 x 310 mm

Capacity approx. 36 l

- Nappy bin in robust, germ-reducing and easy-care stainless steel (AISI 304).
- All-stainless steel housing; all corners fully welded, visible surfaces satin finished and brushed, at the top highly polished.
- Further available surfaces: see below.
- Equipped with removable hygiene bin. Capacity approx. 36 l. Designed for standard garbage bags. Accessible through lockable door.
- Keyed alike cylinder lock in corrosion-resistant zinc die-casting.
- On the top one-hand operated, by 180 ° swiveling, odor-reducing insertion sluice made of polypropylene.
- Wear parts can be replaced as modules.
- With four rubber feet for floor installation.
- Weight, including single package: 13.0 kg



Suggested text for specifications:

Nappy bin in stainless steel (AISI 304) for floor installation. All-stainless steel housing; all corners fully welded, visible surfaces satin finished and brushed, at the top highly polished. Equipped with removable hygiene bin, designed for standard garbage bags. Capacity approx. 36 l. Accessible through lockable door. Keyed alike cylinder lock in corrosion-resistant zinc die-casting. On the top one-hand operated, by 180 ° swiveling insertion sluice made of polypropylene.

Dimensions: 298 x 780 x 310 mm

Article No. WP2505

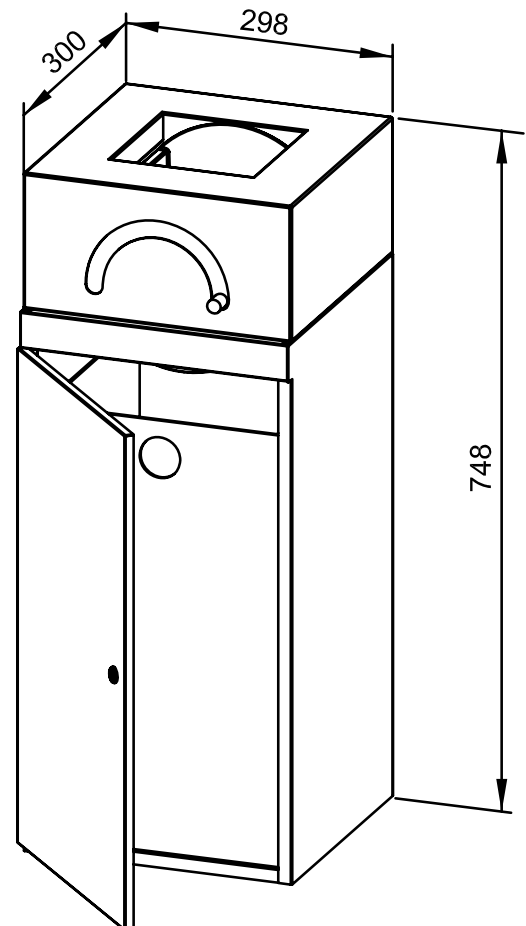

Available surfaces	ID No.
satin finished (standard)	727 685
highly polished	731 685
(coloured) plastic powder-coating	728 685

Ernst Wagner GmbH & Co. KG

Ernst-Abbe-Straße 21 · D-72770 Reutlingen · Tel.: +49712151539-0 · Fax: -20
info@wagner-ewar.de · www.wagner-ewar.de

WAGNER
EWAR