

400 x 298 x 120 mm

400 ml foam soap, 250 paper towels

- Combination consisting of a foam soap dispenser and a paper towel dispenser in robust, germ-reducing and easy-care stainless steel (AISI 304).
- All-stainless steel housing; all corners fully welded, visible surfaces satin finished and brushed.
Further available surfaces: see below.
- Foam soap dispenser with one-hand operated and non-drip foam soap pump.
- Designed for standard 400 ml foam soap concentrate.
- Paper towel dispenser with deep-drawn paper removal opening for easy paper removal.
- Designed for approx. 500 standard paper towels in zigzag fold.
Paper size (folded): 240-250 mm x 100-115 mm.
- Inspection slots to indicate fill level.
- Accessible for refilling through lockable front flap with fall protection.
- Keyed alike cylinder lock in corrosion-resistant zinc die-casting.
- Wear parts can be replaced as modules.
- Mounting: With four screws through key holes and one optional anti-theft hole in the back wall.
- Delivery includes fixing material, first fill with foam soap concentrate and one pack of paper towels.
- Weight, including single package: 3.9 kg



Suggested text for specifications:

Combination consisting of a foam soap dispenser and a paper towel dispenser in stainless steel (AISI 304) for surface mounting. All-stainless steel housing; all corners fully welded, visible surfaces satin finished and brushed. Foam soap dispenser with one-hand operated and non-drip foam soap pump. Designed for standard 400 ml foam soap concentrate. Paper towel dispenser with deep-drawn paper removal opening, filling quantity approx. 500 paper towels. Inspection slots to indicate fill level. Accessible for refilling through lockable front flap with fall protection. Keyed alike cylinder lock in corrosion-resistant zinc die-casting. Delivery includes fixing material, first fill with foam soap concentrate and one pack of paper towels.

Dimensions: 400 x 298 x 120 mm

Article No. WP550-5

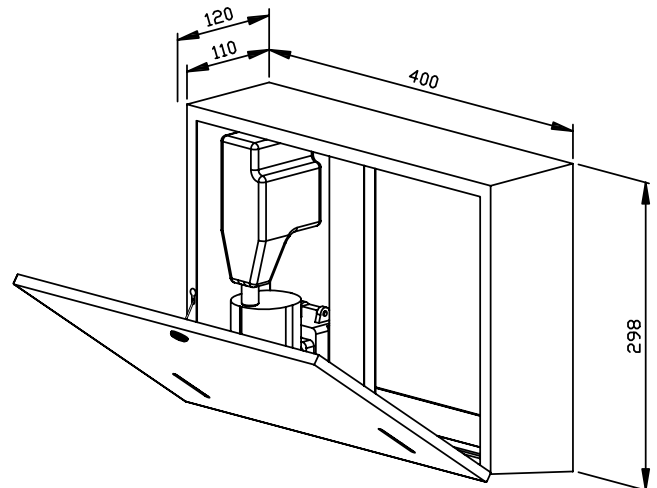

Available surfaces	ID No.
satin finished (standard)	727 787
highly polished	731 787
(coloured) plastic powder-coating	728 787