

WASTE BIN L185



298 x 598 x 180 mm

Capacity approx. 32 l

- Waste bin in robust, germ-reducing and easy-care stainless steel (AISI 304).
- All-stainless steel housing; visible surfaces satin finished and brushed. Further available surfaces: see below.
- Tapered front with vertical curved recess.
- Capacity approx. 32 l.
- Mounting: With two screws through key holes and one optional anti-theft hole in the back wall.
- Delivery includes fixing material.
- Weight, including single package: 4.7 kg



Suggested text for specifications:

Waste bin in stainless steel (AISI 304) for surface mounting. All-stainless steel housing; visible surfaces satin finished and brushed. Tapered front with vertical curved recess. Capacity approx. 32 l. Delivery includes fixing material.

Dimensions: 298 x 598 x 180 mm

Article No. L185

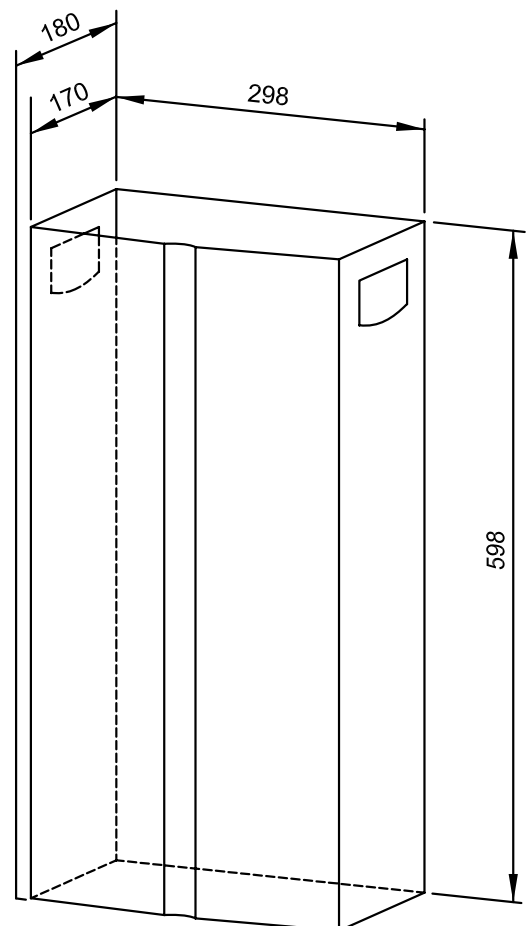

Available surfaces	ID No.
satin finished (standard)	828 160
(coloured) plastic powder-coating	829 160

Ernst Wagner GmbH & Co. KG

Ernst-Abbe-Straße 21 · D-72770 Reutlingen · Tel.: +49712151539-0 · Fax: -20
info@wagner-ewar.de · www.wagner-ewar.de

WAGNER
EWAR